

## MP3-CD Soundmachine

AZ1830

Meet Philips at the Internet

<http://www.philips.com>

User Manual

Manuel d'utilisation

Manual del usuario

Benutzerhandücher



# PHILIPS

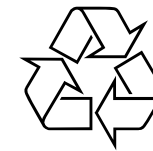

AZ1830

Printed in China

JH-0552

1

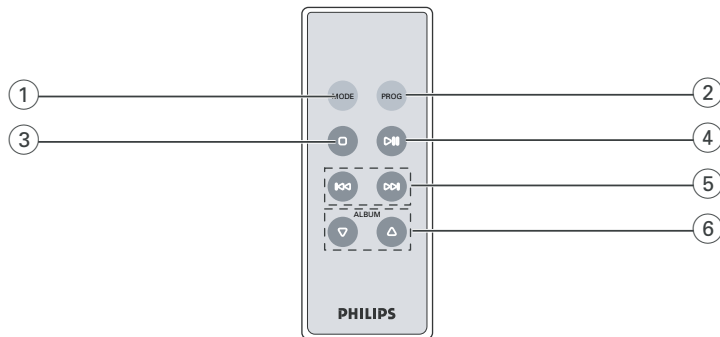
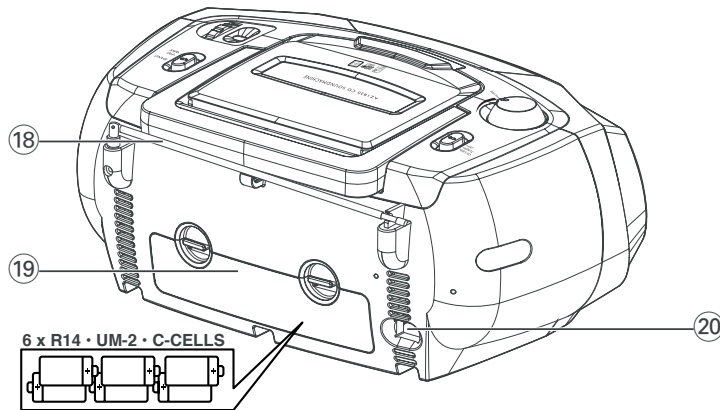
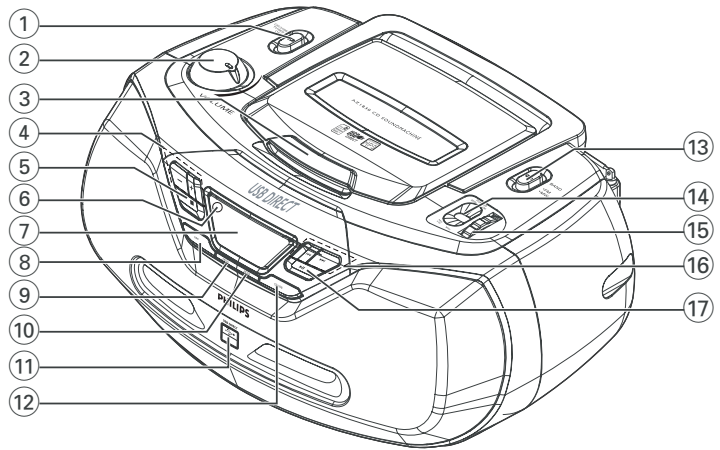

10

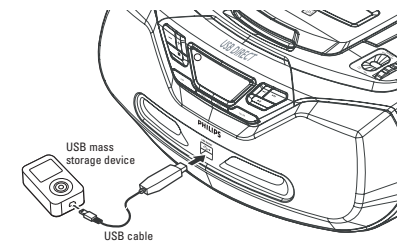
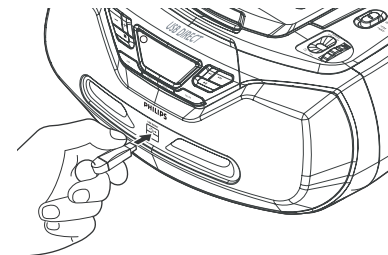
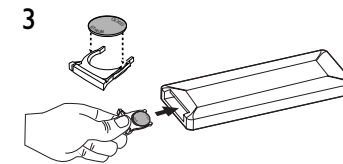
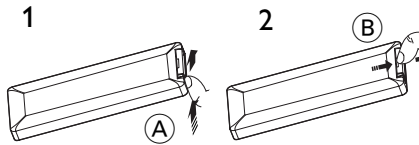
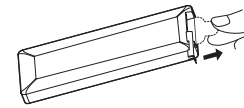

## Important notes for users in the U.K.

### Mains plug

This apparatus is fitted with an approved 13 Amp plug. To change a fuse in this type of plug proceed as follows:

1. Remove fuse cover and fuse.
2. Fix new fuse which should be a BS1362 3 Amp, A.S.T.A. or BSI approved type.
3. Refit the fuse cover.

If the fitted plug is not suitable for your socket outlets, it should be cut off and an appropriate plug fitted in its place. If the mains plug contains a fuse, this should have a value of 3 Amp. If a plug without a fuse is used, the fuse at the distribution board should not be greater than 3 Amp.

Note: The severed plug must be disposed of to avoid a possible shock hazard should it be inserted into a 13 Amp socket elsewhere.

### How to connect a plug

The wires in the mains lead are coloured with the following code: blue = neutral (N), brown = live (L). As these colours may not correspond with the colour markings identifying the terminals in your plug, proceed as follows:

- Connect the blue wire to the terminal marked N or coloured black.
- Connect the brown wire to the terminal marked L or coloured red.
- Do not connect either wire to the earth terminal in the plug, marked E (or e) or coloured green (or green and yellow).

Before replacing the plug cover, make certain that the cord grip is clamped over the sheath of the lead - not simply over the two wires.

### Copyright in the U.K.

Recording and playback of material may require consent. See Copyright Act 1956 and The Performer's Protection Acts 1958 to 1972.

2

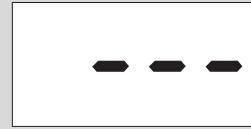

8



3

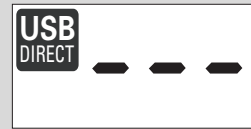

9



4

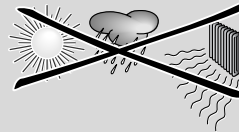
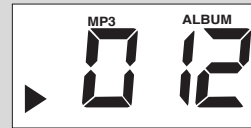

5

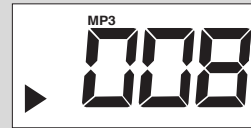

6

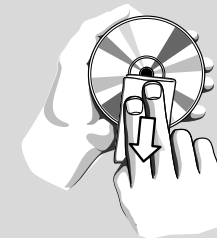

7



## English

### Supplied accessories

- AC power cord
- Remote control

### Top and front panels (See 1)

- ① **Source selector: CD/USB, TUNER, OFF**
  - selects CD/MP3-CD (or USB mode), or radio
  - switches off the set
- ② **VOLUME** – adjusts volume level
- ③ **LIFT TO OPEN** – lifts here to open the disc door
- ④ **ALBUM +/-**
  - **For MP3-CD/ USB play:** select albums
- ⑤ ■ – stops disc/USB playback;
  - erases a program
- ⑥ **iR** – infrared sensor for remote control
- ⑦ **Display** – shows disc/USB play functions
- ⑧ **DBB** – turns the bass enhancement on/off.
- ⑨ **MODE** – selects different play modes: e.g. REPEAT or SHUFFLE (random order)
- ⑩ **PROG** – programs tracks and reviews the program
- ⑪ **USB port** – connects an external USB mass storage device
- ⑫ **CD/USB** – enters disc or USB mode
- ⑬ **BAND** – selects wavebands, MW or FM
- ⑭ **Frequency indicator** – shows the radio frequency of your selected waveband
- ⑮ **TUNING** – tunes to radio stations
- ⑯ **⏮ ⏭**
  - **For disc/ USB play:**
  - skips to the beginning of a current/ previous/ later track
  - fast searches backwards and forwards within a track
- ⑰ **▶||** – starts or pauses disc/USB playback

## Controls / Power Supply

### Back panel (See 1)

- ⑱ **Telescopic antenna** – improves FM reception
- ⑲ **Battery door** – open to insert 6 x 1.5V R-14/ UM2/ C-cells
- ⑳ **AC~ MAINS** – inlet for power cord

### Remote control (See 1)

- ① **MODE** – selects different play modes: e.g. REPEAT or SHUFFLE (random order)
- ② **PROG** – programs tracks and reviews the program
- ③ ■ – stops disc/USB playback;
  - erases a program
- ④ **▶||** – starts/ pauses CD/USB playback
- ⑤ **⏮ ⏭**
  - **For disc/ USB play:**
  - fast searches back and forward
  - skips to the beginning of a current track/ previous/ later track
- ⑥ **ALBUM +/-**
  - **For MP3-CD/USB play:** selects albums

### Power Supply

Whenever convenient, use the power supply cord if you want to conserve battery life. Make sure you remove the plug from the set and wall outlet before inserting batteries.

#### Batteries

##### Main set (See 1)

- Insert **6** batteries, type **R-14, UM2** or **C-cells** (not included, preferably alkaline) with the correct polarity.

## Power Supply

### Remote control (See 1)

#### Important!

- **Before using the remote control, remove the insulation plastic tab as shown in figure 10.**
- **If the remote control does not function correctly or the operating range is reduced, replace the battery with a new (CR2025) type battery**

- 1 Press and hold the latch (A) in the direction as shown in figure 10.
  - 2 Simultaneously, pull the battery tray (B) out.
  - 3 Replace a new battery, and fully insert the battery tray back to the original position.
- Incorrect use of batteries can cause electrolyte leakage and will corrode the compartment or cause the batteries to burst:
  - Do not mix battery types: e.g. alkaline with carbon zinc. Only use batteries of the same type for the set.
  - When inserting new batteries, do not try to mix old batteries with the new ones.
  - Remove the batteries if the set is not to be used for a long time.

**Batteries contain chemical substances, so they should be disposed of properly.**

#### Using AC power

- 1 Check if the power/mains voltage, **as shown on the type plate located on the bottom of the set**, corresponds to your local power supply. If it does not, consult your dealer or service center.
- 2 Connect the power cord to the **AC~ MAINS** inlet and the wall socket. The set is now ready for use.
- 3 To switch the set off completely, withdraw the power cord from the wall socket.
- 4 Install the unit near the AC outlet and where the AC power plug can be easily reached.

- Disconnect the power cord from the wall socket to protect your set during heavy thunderstorms. Children could seriously injure themselves as the free end of the cable may still be live if only the connector is removed from the MAINS socket at the back of the unit.

**The type plate is located on the bottom of the set.**

#### Auto power saving

- When the **source selector** is adjusted to **CD/USB** and the set is in the PAUSE position for **5** minutes, the set will be auto switched to the stop position to save power.
- When the **source selector** is adjusted to **CD/USB** and the set is in the STOP position for **15** minutes, the set will be auto switched to sleep (standby) mode. To wake it up, press **▶||**.

#### Helpful hints:

- To avoid unnecessary energy consumption, always adjust the **source selector** to **OFF** after using the set.

## CAUTION

**- Visible and invisible laser radiation. If the cover is open, do not look at the beam.**

**- High voltage! Do not open. You run the risk of getting an electric shock. The machine does not contain any user-serviceable parts.**

**- Modification of the product could result in hazardous radiation of EMC or other unsafe operation.**

**This set complies with the radio interference requirements of the European Union.**

## Basic Function/ Radio

### Basic functions

#### Switching on/off the set

- 1 To switch on, adjust the **source selector** to **CD/USB** or **TUNER** as desired.
- 2 To switch off, adjust the **source selector** to **OFF**.

#### Adjusting volume and sound

Adjust the sound with the **VOLUME** and **DBB** controls.

### Radio reception

- 1 Push the **source selector** to **TUNER**.
- 2 Adjust the **BAND** to **MW** or **FM** to select your desired waveband.
- 3 Turn **TUNING** to tune in a radio station.
- 4 To switch off the radio, adjust the **source selector** to **OFF**.

#### Helpful hints:

##### To improve reception

- For **FM**, extend, incline and turn the telescopic antenna. Reduce its length if the signal is too strong.
- For **MW**, uses a built-in antenna. Direct this antenna by turning the whole set.

## MP3-CD/ CD Player

### About MP3

The music compression technology MP3 (MPEG1 Audio Layer 3) significantly reduce the digital data of an audio CD while maintaining CD quality sound.

- **Getting MP3 files:** you can either download legal music files from the internet to your computer hard disc, or create such files by converting audio CD files in your computer through appropriate encoder software. (128kbps bit rate or higher is recommended for MP3 files.)
- **Creating a MP3 CD:** burn the music files from your computer hard disc on a CDR or CDRW using your CD burner.

#### Helpful hints:

- Make sure that the file names of the MP3 files end with **.mp3**.
- Total number of music files and albums: around 350 (with a typical file name length of 20 characters)
- The length of file names affects the number of tracks for playback. With shorter file names, more files can be burned on a disc.

### Playing a disc

This player plays Audio Discs including CD-R/ CD-RW, and MP3 CD. Do not try to play a CD-ROM, CD-I, CDV, VCD, DVD or computer CD.

#### IMPORTANT!

- CDs encoded with **copyright protection technologies** by some record companies may be unplayable by this product.
- 1 Adjust the **source selector** to **CD/USB**.  
→ Display shows - - - (see [2]), or - - - with "USB DIRECT" (see [3])

## MP3-CD/ CD Player

- 2 Press **CD/USB** to enter CD mode if USB DIRECT is displayed.  
→ Display will show --- (See [2]).
  - 3 To open the disc door, lift the disc door at the edge marked **LIFT TO OPEN**.
  - 4 Insert a disc with the printed side facing up and press the disc door gently to close.  
→ Display: The total number of tracks appears.
  - 5 Press **▶||** to start playback.  
→ Display: ▶ and the current track number.
- For MP3-CD only:**
- The current track number "X X X" and album number "**ALBUM** X X X" will be displayed interchangeably (See [4] [5]).
  - 6 To pause playback press **▶||**.  
→ Display: ▶ and the current track number flash.
  - 7 Press **▶||** again to resume playback.
  - 8 To stop playback, press **■**.

#### Helpful hints:

- The disc playback will also stop when:
- you open the disc compartment door;
  - you select **TUNER** or **OFF** position;
  - the disc has reached the end of the playback.

### Selecting a different track

- Press **◀** or **▶** once or repeatedly until the desired track number appears in the display.  
**For MP3-CD:** First press **ALBUM +/-** once or more to find your album.
- In the pause/stop position, press **▶||** to start playback.

### Finding a passage within a track

- 1 During playback, press and hold down **◀◀** or **▶▶**.  
→ The disc is played at high speed and low volume.
- 2 When you recognize the passage you want, release **◀◀** or **▶▶**.  
→ Normal playback resumes.

### Programming tracks

You may store up to 20 tracks in the desired sequence. If you like, store any track more than once.

- 1 In the stop position, press **PROG** to start programming.  
→ Display shows **P 0 1** indicating the start of the program. **PROG** flashes. (See [6])
- 2 Press **◀** or **▶** to select your desired track number.  
**For MP3-CD:** First press **ALBUM +/-** once or more to find your album.
- 3 Press **PROG** to store the desired track.  
→ Display shows **P 0 2**, indicating the next program location available.
- 4 Repeat steps 2 to 3 to select and store all desired tracks.
- 5 Press **▶||** to play the program.

#### To review your program

In the stop position, press and hold **PROG** 3 seconds.  
→ The display shows all the stored tracks in sequence.

#### Helpful hints:

- Display shows **P 0 1** if no track is programmed
- If you try to store more than 20 tracks, no track can be selected and the display will show **FULL**.

## MP3-CD/ CD Player

### To erase a program

You can erase a program by:

- pressing **■** (twice during playback or once in the stop position);
  - selecting **TUNER** or **OFF** position;
  - opening the disc door.
- Display: **PROG** disappears.

### Selecting different play modes (See **7** **8**)

You can select and change the various play modes before or during playback, and combine REPEAT modes with **PROG**.

**REP** – plays the current track continuously.

**REP ALL** – plays the entire disc/program continuously.

**SHUF** – plays all tracks in random order.

- 1 To select play modes, press **MODE** once or more.
- 2 Press **▶II** to start playback if in the stop position.
- 3 To select normal playback, press **MODE** repeatedly until the various modes are no longer displayed.  
– You can also press **■** to cancel your play modes.

## USB Connection

### Using USB connectivity

- AZ1830 is fitted with a USB port in the front panel, offering a plug and play feature which allows you to play, from your AZ1830, digital music and spoken contents stored on a USB mass storage device.
- Using a USB mass storage device, you can also enjoy all the features offered by AZ1830 which are explained and instructed in the sections of disc operation.

### Compatible USB mass storage devices

With the AZ1830, you can use

- USB flash memory (USB 2.0 or USB 1.1)
- USB flash player (USB 2.0 or USB 1.1)

- USB device which requires driver installation under Windows XP is not supported.

### Note:

In some USB flash players (or memory devices), the stored contents are recorded using copyright protection technology. Such protected contents will be unplayable on any other devices (such as AZ1830 device).

### Supported formats:

- USB or memory file format FAT12, FAT16, FAT32 (sector size: 512 - 65,536 bytes)
- MP3 bit rate (data rate): 32-320 kbps and variable bit rate
- WMA v9 or earlier
- Directory nesting up to a maximum of 8 levels
- Number of albums: maximum 99
- Number of tracks: maximum 400
- ID3 tag v2.0 or later
- File name in Unicode UTF8 (maximum length: 128 bytes)

## USB Connection

### The system will not play or support the following:

- Empty albums: an empty album is an album that does not contain MP3/WMA files, and will not be shown in the display.
- Non-supported file formats are skipped. This means that e.g.: Word documents .doc or MP3 files with extension .dlf are ignored and will not be played.
- AAC, WAV, PCM, NTFS audio files
- DRM protected WMA files
- WMA files in Lossless format
- MP3 files in Lossless format

### Playing a USB mass storage device

- 1 Make sure that your AZ1830 is being powered by AC mains or specified batteries.
- 2 Adjust the **source selector** to **CD/USB**.  
→ Display shows - - - (see **2**), or - - - with USB DIRECT (see **3**)
- 3 Press **CD/USB** to enter USB mode if USB DIRECT is NOT displayed.  
→ Display will show USB DIRECT (see **2**).
- 4 As shown in figure **11**, plug a compatible USB mass storage device to AZ1830's USB port marked **↔**. If needed, use a suitable USB cable to connect between the device and AZ1830's USB port.  
→ The device will automatically power on.
- If the device is not powered on, turn on the power manually, then re-connect it.  
→ AZ1830's display shows USB DIRECT and the total number of playable audio files (Max. displayed track number is 400) stored on the device.
- 5 Press **▶II** on your AZ1830 to start play.  
→ AZ1830's display will show USB DIRECT and share the display information illustrated in the disc operation.

### Helpful hints:

- Up to 400 playable audio files stored on a USB mass storage device can be played on AZ1830.
- Up to 99 playable albums stored on a USB mass storage device can be selected and displayed on AZ1830.
- Make sure that file names of MP3 files end with .mp3. and the file names of WMA files end with .wma.
- For DRM protected WMA files, use Windows Media Player 10 (or later) for conversion. Visit [www.microsoft.com](http://www.microsoft.com) for details about Windows Media Player and WM DRM (Windows Media Digital Rights Management).

## Safety & Maintenance (See 9)

### Safety information

- Place the set on a hard, flat and stable surface so that the system does not tilt.
- Do not expose the set, batteries, CDs to humidity, rain, sand or excessive heat caused by heating equipment or direct sunlight.
- The apparatus shall not be exposed to dripping or splashing.
- Adequate ventilation with a minimum gap of 15 cm between the ventilation holes and surrounding surfaces is necessary to prevent heat build-up.
- The ventilation should not be impeded by covering the ventilation openings with items, such as newspapers, table-cloths, curtains, etc..
- No objects filled with liquids, such as vases, shall be placed on the apparatus.
- No naked flame sources, such as lighted candles, should be placed on the apparatus.
- The mechanical parts of the set contain self-lubricating bearings and must not be oiled or lubricated.
- To clean the set, use a dry cloth. Do not use any cleaning agents containing alcohol, ammonia, benzene or abrasives as these may harm the housing.

### CD player and CD handling

- If the CD player cannot read CDs correctly, use a cleaning CD to clean the lens before taking the set to repair.
- The lens of the CD player should never be touched!
- Sudden changes in the surrounding temperature can cause condensation on the lens of your CD player. Playing a CD is then not possible. Do not attempt to clean the lens but leave the set in a warm environment until the moisture evaporates.
- Always close the CD door to avoid dust on the lens.
- To clean the CD, wipe in a straight line from the center towards the edge using a soft, lint-free cloth. Do not use cleaning agents as they may damage the disc.
- Never write on a CD or attach any stickers to it.

## Troubleshooting

If a fault occurs, first check the points listed below before taking the set for repair. If you are unable to remedy a problem by following these hints, consult your dealer or service centre.

**WARNING:** Do not open the set as there is a risk of electric shock. Under no circumstances should you try to repair the set yourself, as this will invalidate the guarantee.

### No sound/ power

- Volume not adjusted
- Adjust the VOLUME
- Power cord not securely connected
- Connect the AC power cord properly
- Batteries dead/ incorrectly inserted
- Insert (fresh) batteries correctly
- Disc contains non-audio files
- Insert a suitable disc or press **SEARCH** **◀◀** or **▶▶** once or more skip to an audio track, instead of the data files.

### Display does not function properly/No reaction to operation of any of the controls

- Electrostatic discharge
- Switch off and unplug the set. Reconnect after a few seconds.

### CD indication

- It is set in the USB mode.
- Press **CD/USB** to select CD mode.
- No disc inserted
- Insert a suitable disc
- Disc badly scratched or dirty
- Replace/clean CD (See Maintenance)
- CD-R(W) is blank or the disc is not finalized.
- Use a finalized CD-R(W)
- Laser lens steam up
- Wait until lens has cleared.

### Note:

**Make sure the CD is not encoded with Copyright protection technologies, as some do not conform to the Compact Disc standard.**

### The disc skips tracks

- Disc damaged or dirty
- Replace or clean disc
- Shuffle or program is active
- Switch off shuffle/program

### Note:

**For a disc with CD Audio tracks and MP3 files, only the CD Audio tracks will be played.**

### Sound skips during MP3 playback

- MP3 file made at compression level exceeding 320kbps
- Use a lower compression level to record CD tracks into MP3 format
- Disc damaged or dirty
- Replace or clean disc.

### The USB device doesn't play on my AZ1830

- It is not set in the USB mode.
- Press **CD/USB** to select USB mode.
- The device is not securely connected to AZ1830's USB port.
- Re-connect the device, and make sure that the device is powered on.
- The device is not supported by AZ1830, or the audio file format stored on the device is not supported by AZ1830.
- Use a compatible device/ playable audio file format.

### **Environmental information**

All unnecessary packaging material has been omitted. The packaging can be easily separated into three materials: cardboard, polystyrene and plastic.

**Your set consists of materials which can be recycled if disassembled by a specialized company. Please observe the local regulations regarding the disposal of packaging, dead batteries and old equipment.**

### **Disposal of your old product**

Your product is designed and manufactured with high quality materials and components, which can be recycled and reused.

When this crossed-out wheeled bin symbol is attached to a product it means the product is covered by the European Directive 2002/96/EC.



Please inform yourself about the local separate collection system for electrical and electronic products.

Please act according to your local rules and do not dispose of your old products with your normal household waste. The correct disposal of your old product will help prevent potential negative consequences for the environment and human health.